

1. Thread the wire lace into the boots, and the ends of the wire lace go through into the base of the reel knob.

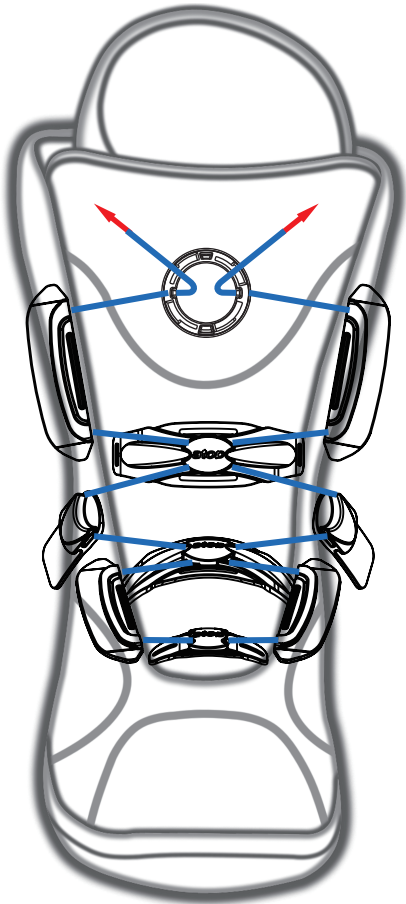

1

2. Turn the knob and align the arrows to any of the four hooks.

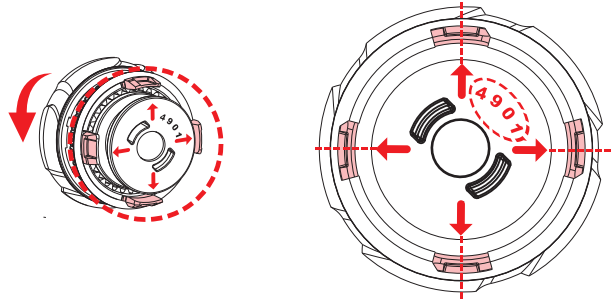

Ⓢ Please check the reel is 4901

3. Fix both ends of the wire lace to the reel

( 1 ) Pass the wire through hole 1

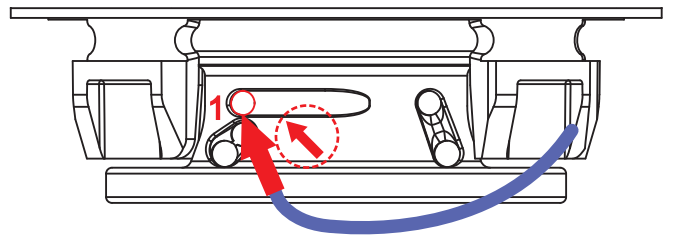

Ⓢ The arrow is hole 1

2

( 2 ) Thread the wire lace straight through hole 1 & 2

( 3 ) Bend the wire lace straight into hole 3 & 4



( 4 ) Thread wire's terminal back to hole 4 to the bottom

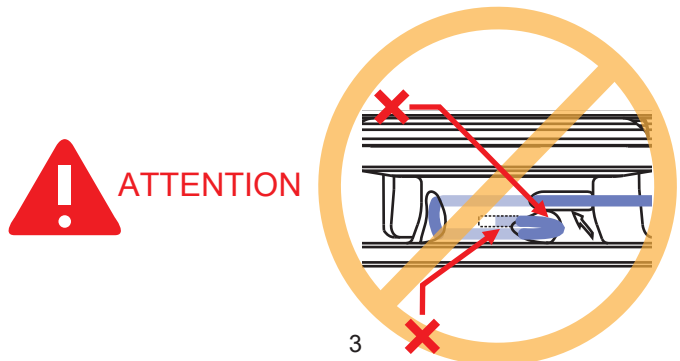
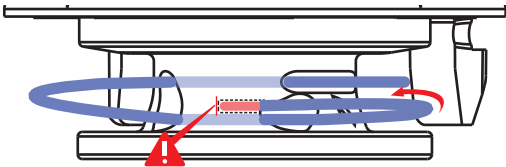

3

( 5 ) Keep your finger press on the loop, pull wire with your right hand to make the loop slip to the bottom tightly

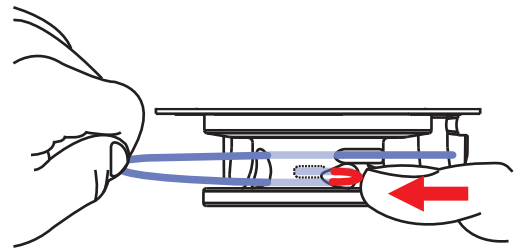

( 6 ) Pull the wire lace with your left hand to tighten the wirelace

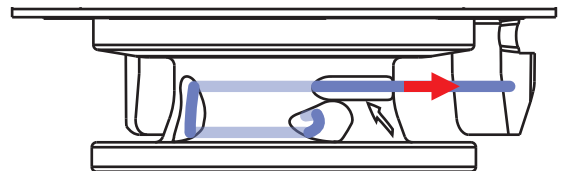

( 7 ) Repeat above steps to the other side of wire lace

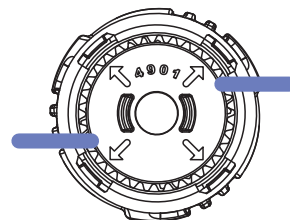

4

**!** ATTENTION

#### 4. Install knob body

- 1. Pass the wire through the channel of the base align in parallel and insert the four hooks to the grooves.

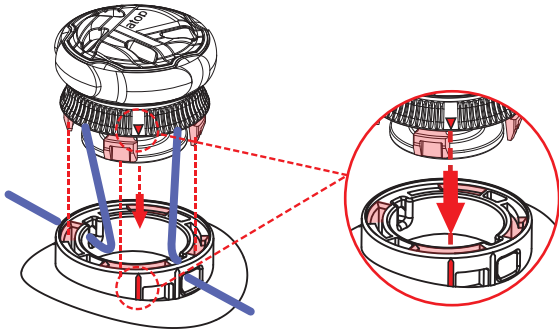

- 2. Turn the knob on the counterclockwise, and ensure that the arrow on the top knob and the one on the base are aligned. After you hear the "Click" sound, this means that the procedure is done.

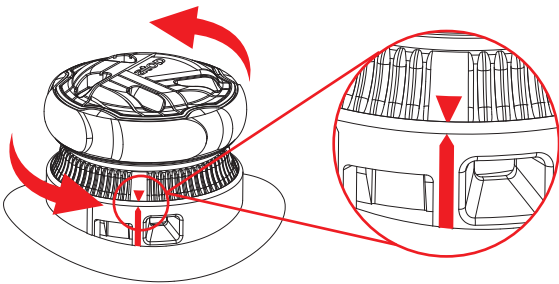

5

#### 5. Function test - Tightening and Loosening

- 1. Turn the knob to clockwise direction to tighten the system
- 2. Release the wire lace in anticlockwise

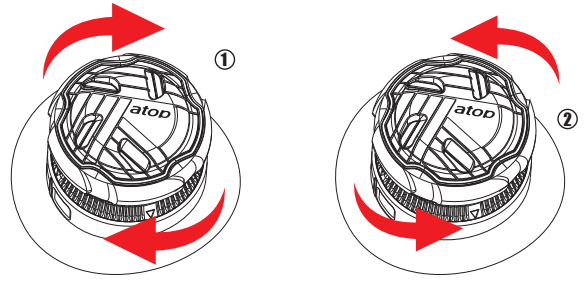

- 3. Repeat this procedure 3 times to ensure that the system is working properly.

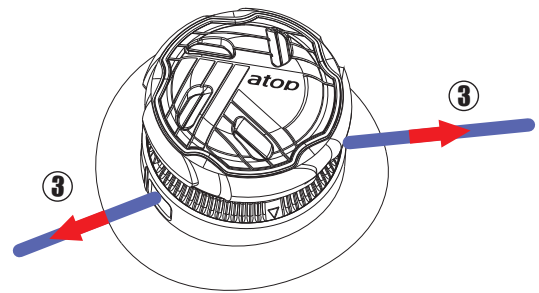

6

#### Remove ATOP knob

- 1. Step 1: Take a small flat screw driver (with head 3mm, as width) and insert it at the left side of the bottom of the hook.  
Step 2: Once inserted, push inward till the end at clockwise direction.

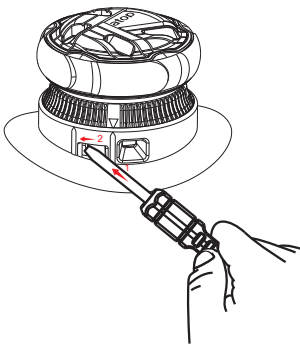

- 2. Then, the arrow on the knob will get aligned with the arrow at the bottom left side of the base.

Before

After

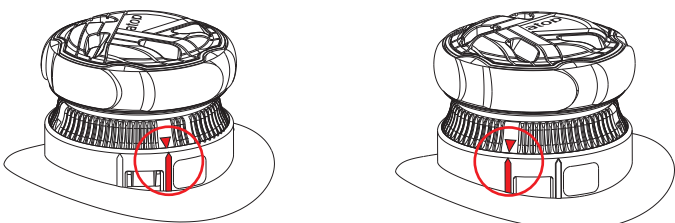

- 3. Ensure this step 2 is done correctly before disassembly, as shown in red part.

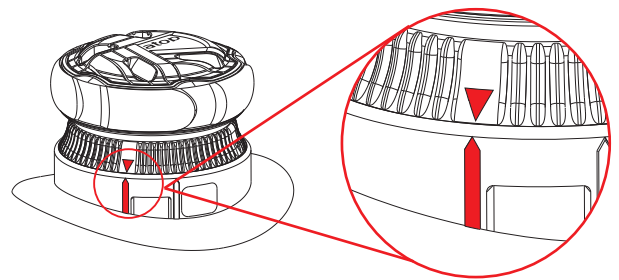

- 4. Hold firmly the knob and pull it up to disassemble it from the base.

